

## io tavolo Datenblatt

LED Tischleuchte mit kugelförmigem Kopf, frei beweglich durch Occhio 3d-Kinematik mit zwei im Winkel von 22,5° zueinander stehenden Drehachsen, Bedienung über wärmeentkoppelte Grip-pads. Lichtwirkung über optionale inserts veränderbar, dichroitische Farbfilter zusätzlich einsetzbar. Leistung 13 W oder 18 W (vorwählbar), schalt- und dimmbar per Gestensteuerung über Touchless-Sensor (deaktivierbar). Stromversorgung über Steckernetzteil (Konverter), Kabel im Fuß aufrollbar. Oberflächenkombinationen von Kopf, Pads, Arm und Fuß frei konfigurierbar, Pads wechselbar.

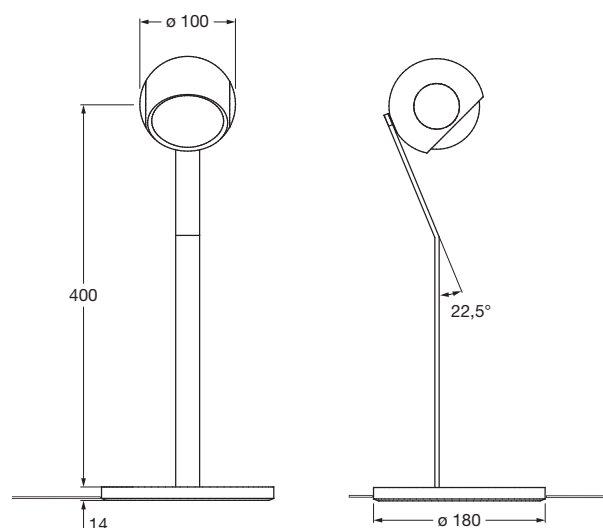

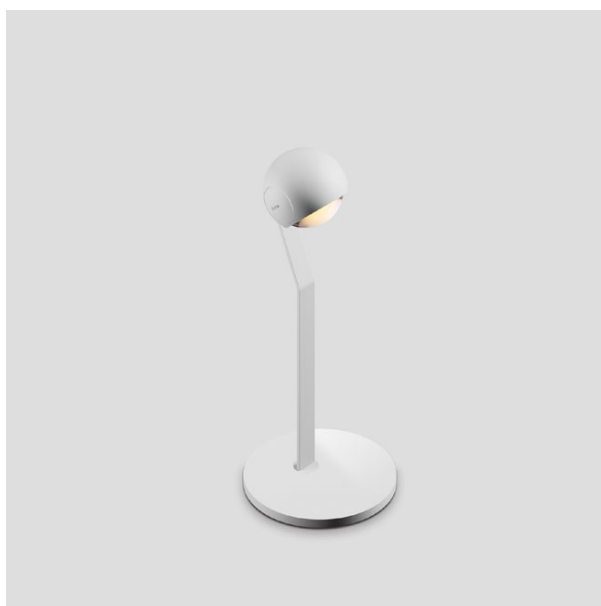

















Maße in mm

### technische Daten io tavolo

<b>Eigenschaften</b>	Material	Aluminium, Zink verchromt oder lackiert, optischer Kunststoff, Glas
	Drehbereich head	360°
	Drehbereich body	360° (mit Anschlag)
	Gewicht	2,40 kg
<b>Oberfläche</b>	head	gold matt, rose gold, bronze, chrom glanz, chrom matt, weiß glanz, weiß matt, schwarz matt, phantom, black phantom
	pads	rose gold, bronze, chrom glanz, chrom matt, weiß glanz, weiß matt, schwarz matt
	body	chrom glanz, chrom matt, weiß matt, schwarz matt
	base	chrom glanz, chrom matt, weiß glanz, weiß matt, schwarz matt
<b>Occhio LED</b>	mittlere Lebensdauer	> 50.000 Std.
	Energieeffizienzklasse (Lichtausbeute)	G (63 lm / W)
	Leistung	LED 18 W (inkl. Occhio Vorschaltgerät 22 W, standby < 0,5 W) / LED 13 W (inkl. Occhio Vorschaltgerät 15 W, standby < 0,5 W)
	Farbwiedergabeindex	perfect color; CRI Ra 97 high flux; CRI Ra 85
Farbtemperatur (Farbkonsistenz)	2700 K, 3000 K (2-step) 3000 K, 3500 K, 4000 K (2-step)	
<b>Elektrik</b>	Dimmung	über im Kopf integrierten touchless Sensor
	Vorschaltgerät	mit integriertem Konverter, Kabellänge 180 cm
	Powerfaktor Netzteil (cos φ1)	0,9
	Flimmer / Stroboskop-Effekt	1 (PstLM) / 0,9 (SVM)
	zulässige Betriebsbedingung	max. 30°C nur im Innenbereich betreiben

## io tavolo Übersicht inserts

io head				
satiniertes Glas				
soft edge Glas				
Fresnel-Linse				
Farbfilter (optional, Lichtleistung max. 13 W)				
Linse				
				
	io C	io C mit soft edge Glas	io C mit satiniertem Glas	io C mit Fresnel-Linse

## io tavolo Lichtwirkungen

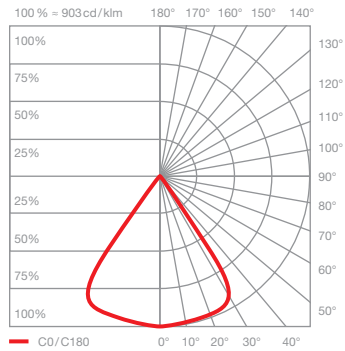
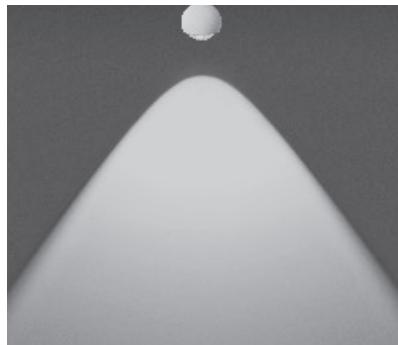

### io C gerichtetes Licht (ca. 80°)

inserts:	Linse		
Lichtstrom:	perfect color	18 W	1170 lm
	high flux	18 W	1610 lm
	perfect color	13 W	800 lm
	high flux	13 W	1170 lm

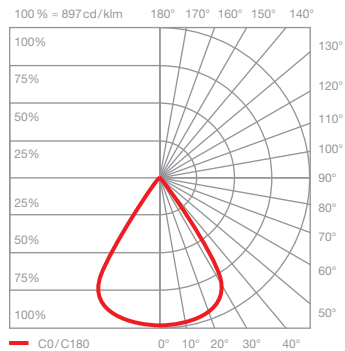
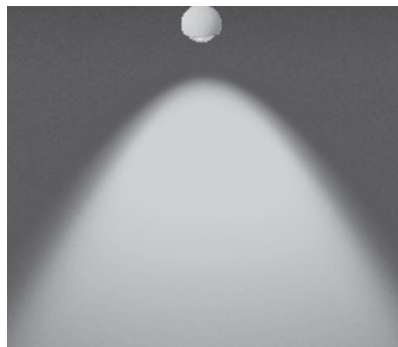

### io C mit soft edge Glas gerichtetes Licht mit weichen Konturen des Lichtkegels (ca. 80°)

inserts:	Linse soft edge Glas		
Lichtstrom:	perfect color	18 W	1070 lm
	high flux	18 W	1470 lm
	perfect color	13 W	740 lm
	high flux	13 W	1070 lm

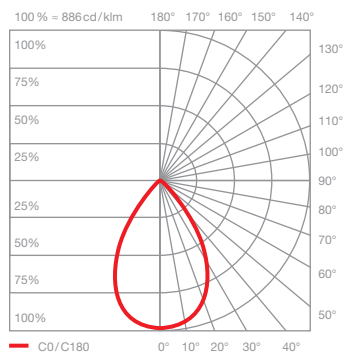
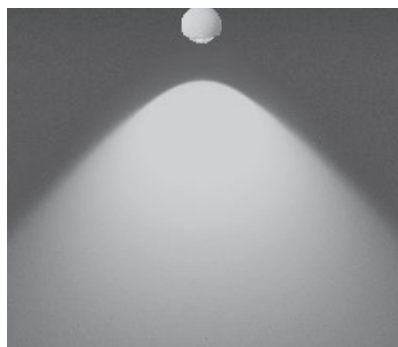

### io C mit satinierem Glas gestreutes Licht mit sanfter Aufweitung des Lichtkegels (ca. 100°)

inserts:	Linse satinieretes Glas		
Lichtstrom:	perfect color	18 W	910 lm
	high flux	18 W	1250 lm
	perfect color	13 W	630 lm
	high flux	13 W	910 lm

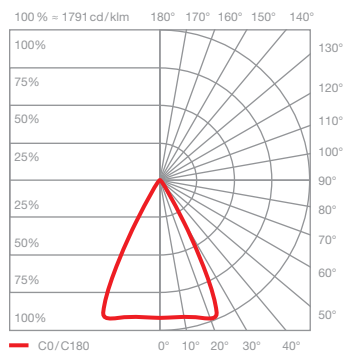
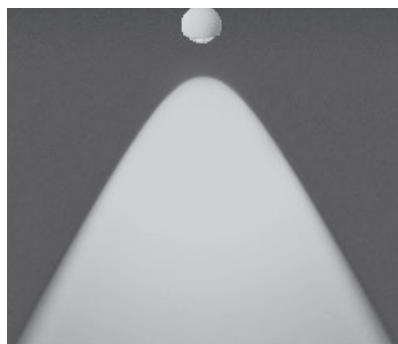

### io C mit Fresnel-Linse gebündeltes Licht Lichtkegel ca. 60°

inserts:	Linse Fresnel-Linse		
Lichtstrom:	perfect color	18 W	990 lm
	high flux	18 W	1360 lm
	perfect color	13 W	680 lm
	high flux	13 W	990 lm